

SOLID Bifacial

108 cell

Framed_Glass/Glass_Full_Black



Fire class A

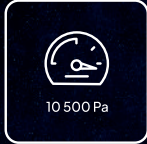

Extreme load resistance

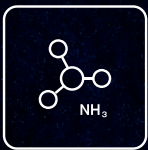

Ammonia resistance

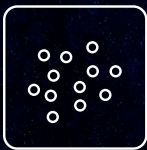

Salt mist resistance



98 % recyclable



Hail resistance class 4



35% of recycled glass content



Positive sorting up to +5W

Front side ⚡ 435 W



Deutsches Institut für Bautechnik

DIBt

30 Year product warranty

90% Power warranty

30 Year efficiency warranty

Electrical data (STC*)	
Maximum power (W)	435
Cell technology	N type, TOPCon - bifacial
Open circuit voltage (V_{oc}/V)	38,92
Short circuit current (I_{sc}/A)	13,80
Max power voltage (V_{mpp}/V)	32,96
Max power current (I_{mpp}/A)	13,20
Module efficiency (η)	22,27%
Max system voltage (V)	1000
Max current (A)	22
Power tolerance	0/+5W

*Under standard test conditions (STC) of irradiance of 1000W/sq.m., spectrum AM1.5 and cell temperature of 25°C. Flash testing measurement accuracy of +/-5%.

Warranty	
30 years product warranty	
30 years efficiency warranty	
First year degradation (%)	1%
Annual degradation (%)	0,31%
Power in year 30 (%)	90%

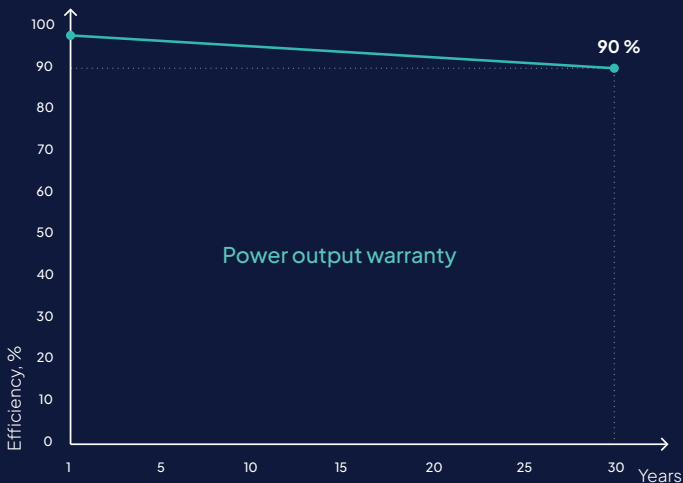
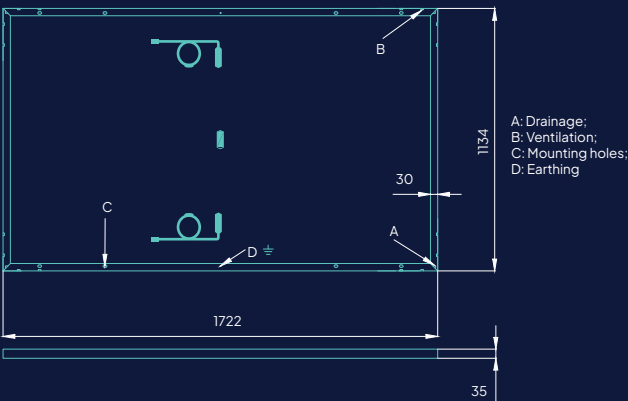

Temperature ratings	
Current temperature coefficient (α)	+0.045% / °C
Voltage temperature coefficient (β)	-0.250% / °C
Power temperature coefficient (δ)	-0.300% / °C
Nominal operating module temperature	46 °C

Mechanical data	
Dimensions (LxWxH) (mm)	1722x1134x35 mm
Weight (kg)	33
Front glass (mm)	3,2 with AR coating
Back glass (mm)	3,2, black
Cell Size (mm)	182x91,875
Busbars	10
Cell configuration	6x18
Frame	Black anodized aluminium frame
Rated operating altitude	Up to 2000 m
Operating temperature (°C)	-40 ÷ +85
Maximum test load (wind/snow) (Pa)	5400/10500
Junction box / IP class	Split junction box / IP68
Cable cross section size (mm ²)	4
Cable length	1,2 m
Bypass diodes	3
Connector	MC4-EVO2

Packing information	
Modules per pallet	24 pcs
Dimensions of a pallet (LxWxH)	1835x1205x1130 mm
Weight of a pallet (gross)	858 kg
Pallets per 13,6 m truck	28 pcs
Modules per 13,6 m truck	672 pcs

Certifications	
IEC 61215:2021; IEC 61730:2016	
Cradle to Cradle (C2C)	Gold level
abZ/aBG	Overhead Glazing
IEC 62716:2013	Ammonia corrosion testing
IEC 61701:2020	Salt mist corrosion testing
IEC 61215-2:2021	39mm hailstone - Hail resistance class 4 (HW4)
ISO 9001:2015	Quality management systems
ISO 14001:2015	Environmental management systems
ISO 45001:2018	Occupational health and safety
SundaHus	A level assessment
Produced using 100% renewable energy	
Membership at Svensk Solenergi	



This datasheet is not legally binding. The manufacturer reserves the right to make changes to product specifications and / or product features without prior notice. The most recent versions of all documents (T&C's, datasheets, warranties and installation manuals) can always be found on our website at www.solitek.eu

